

O S S E R I E S

oil-injected screw compressors



i n c r e a s i n g r e l i a b i l i t y

Operating range of the series

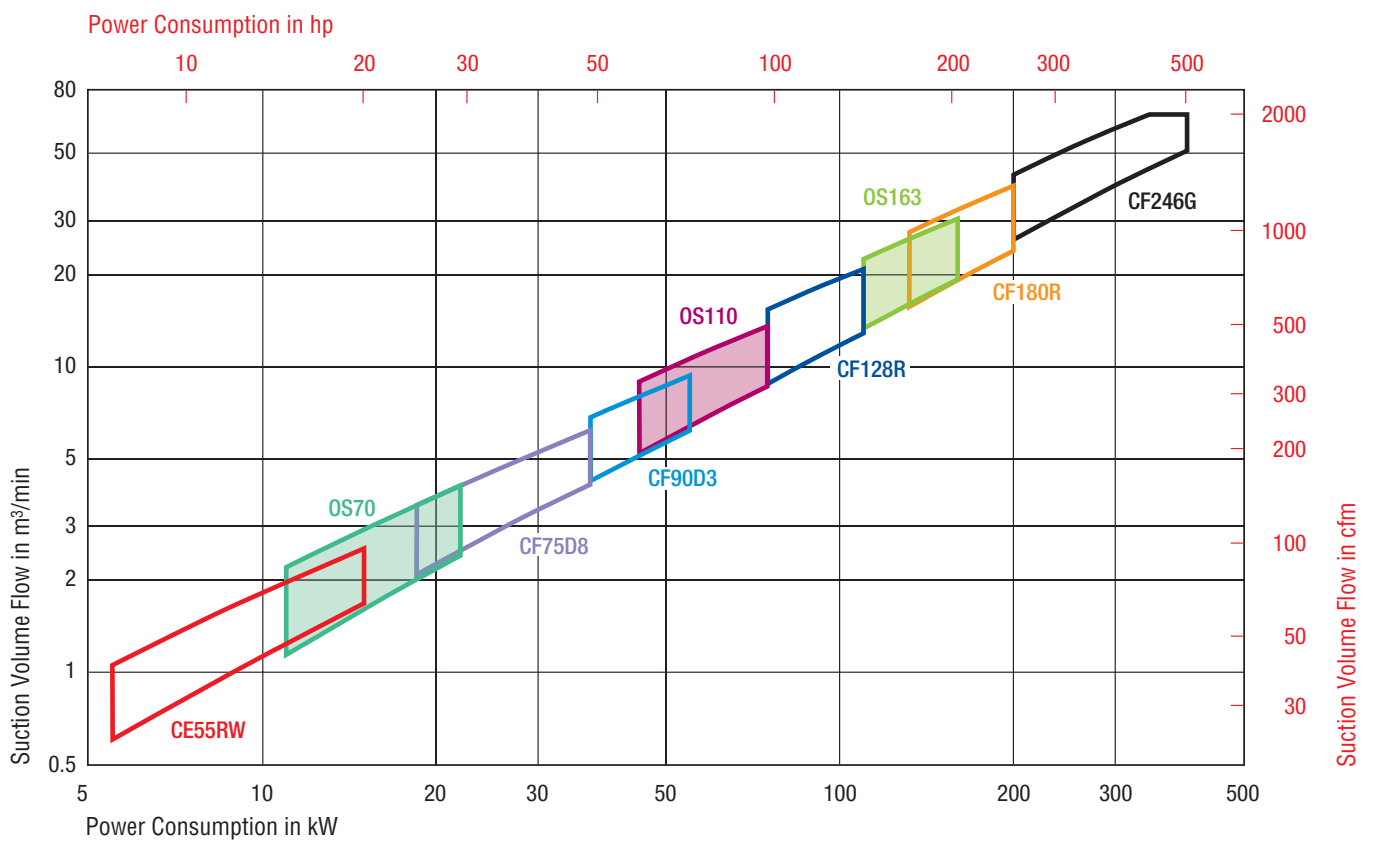

GHH RAND is one of the world's leading air-technology companies. Since over 50 years GHH RAND develops, designs, and manufactures oil-injected and oil-free compressed air solutions for many different industries and applications. We offer a wide range of solutions and services for air and gas compression: from airends to customized compressed air systems, always with highest reliability in the industry. Our work is driven by passion to high technology and high performance.

For production of our screw airends we utilize newest and advanced technologies, which allow us to reach minimum manufacturing tolerances, high precision assembly and testing under extreme conditions. The quality of our airends is very well known and acknowledged world wide.

Our engineers continuously develop our products in order to fulfill and even exceed customer's requirements. Highest efficiency and reliability in the market are results of improvement of airend design and production processes done over the years.

Our delivery program includes belt driven, direct driven and gear driven airends. The airends built with high precision are suited for work under the most difficult conditions 24 hours per day. Many features and highlights of the airends allow OEM-customers easy selling of their products to end users.

Recently we added to our famous series CE & CF the newest development OS series. With the new OS series we reached even higher level of efficiency of screw compressors. Simplicity of the design increases its reliability.

The highlights of our airends

GHH RAND rotor profiles _provide maximum performance and efficiency – more volume flow with less motor power

Bearings arrangement _robust radial and axial bearings guarantee extremely long service life

Triple lip seal _eliminates leakage problems through three sealing lips and special return path to the section side of the airend

Belt drive _in any airend the bearing loads created by interaction of medium (air) forces with external forces coming from belt load.

Direct drive _reliable solution for cost oriented applications

Base and face mounting _flexible fits to every package design

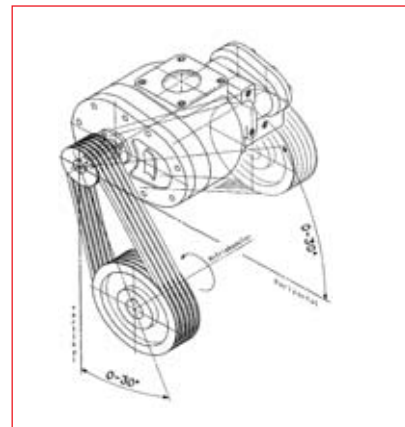

PERFORMANCE OS70

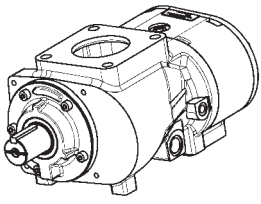

Length _368 mm _14.5 inch
 Width _217 mm _8.5 inch
 Height _195 mm _7.7 inch
 Weight _43 kg _95 lbs

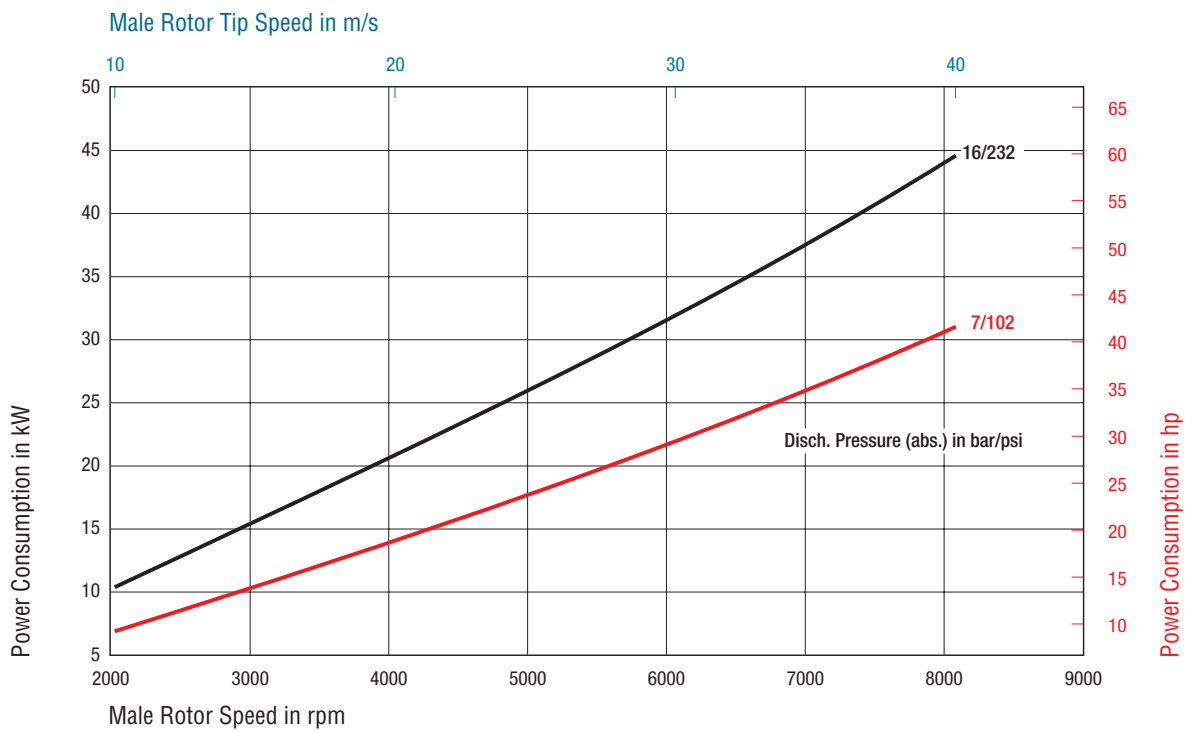
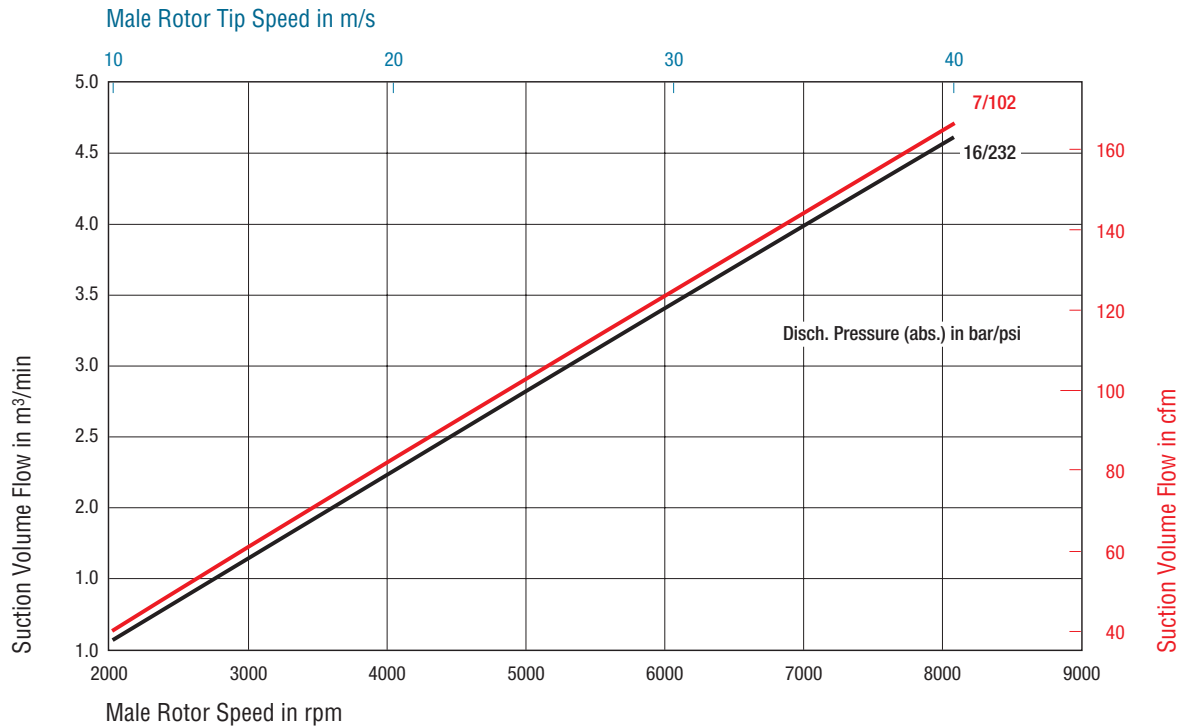

Medium: air; relative humidity: 60%; suction press. (abs.): 1 bar/14.5 psi;
 suction temp.: 20°C/68°F; disch. temp.: 80°C/176°F; oil quality: ISO VG46

PERFORMANCE OS110*

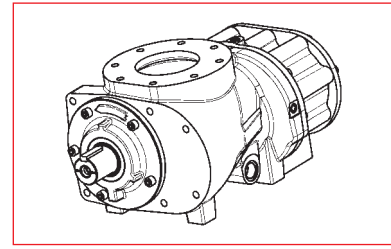

Length _550 mm _21.7 inch
 Width _364 mm _14.3 inch
 Height _302 mm _11.9 inch
 Weight _150 kg _331 lbs

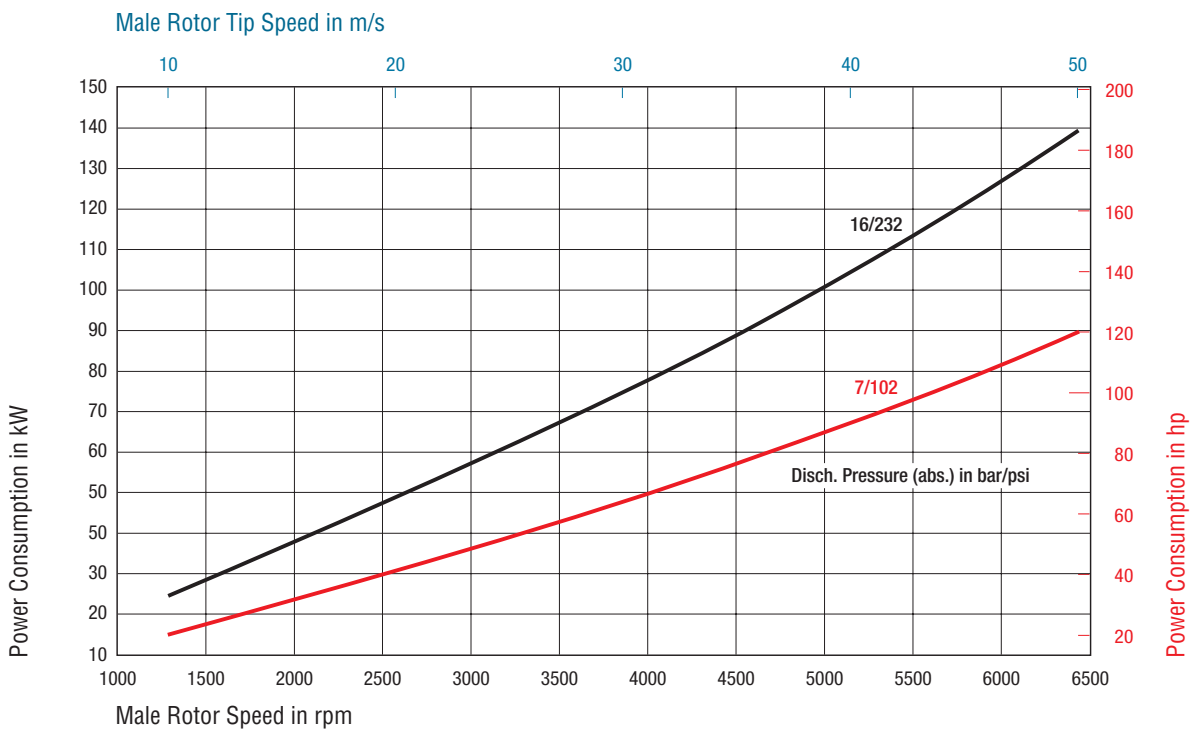
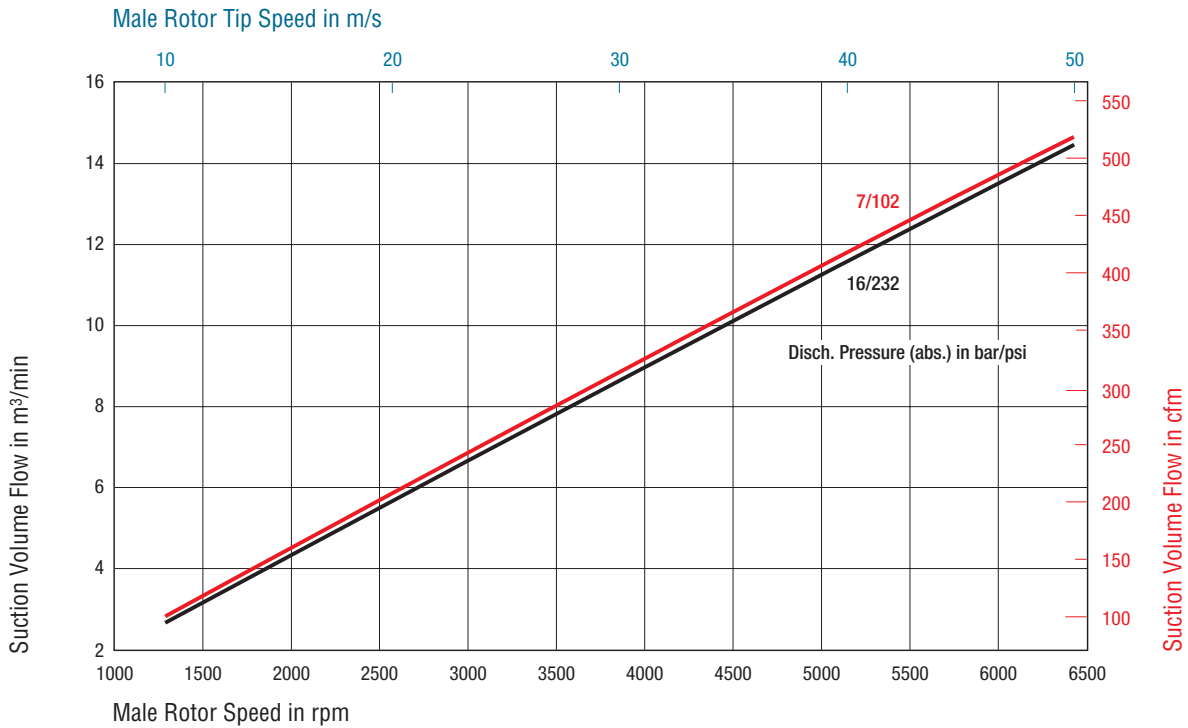

* Preliminary data. Subject to change.

PERFORMANCE OS163*

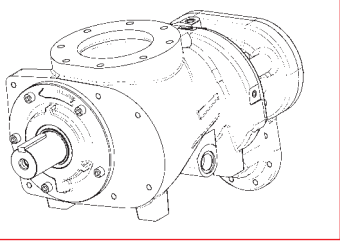

Length _800 mm _31.5 inch
 Width _550 mm _21.7 inch
 Height _600 mm _23.6 inch
 Weight _430 kg _948 lbs

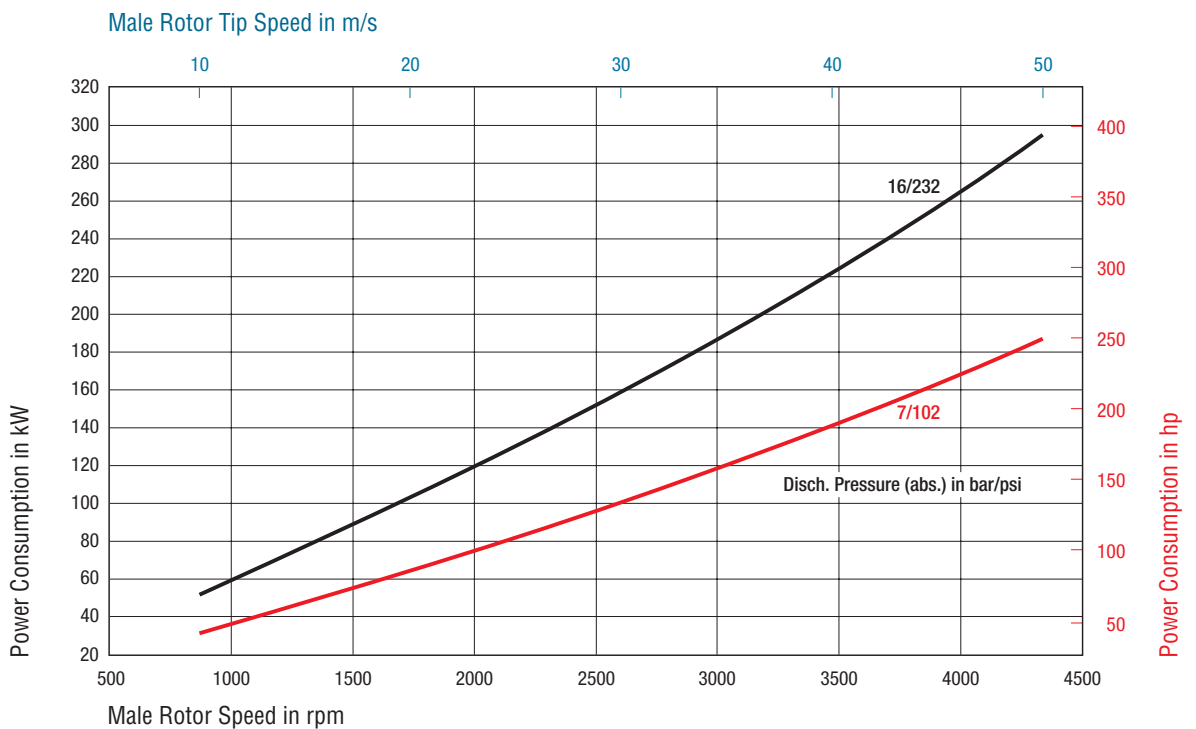
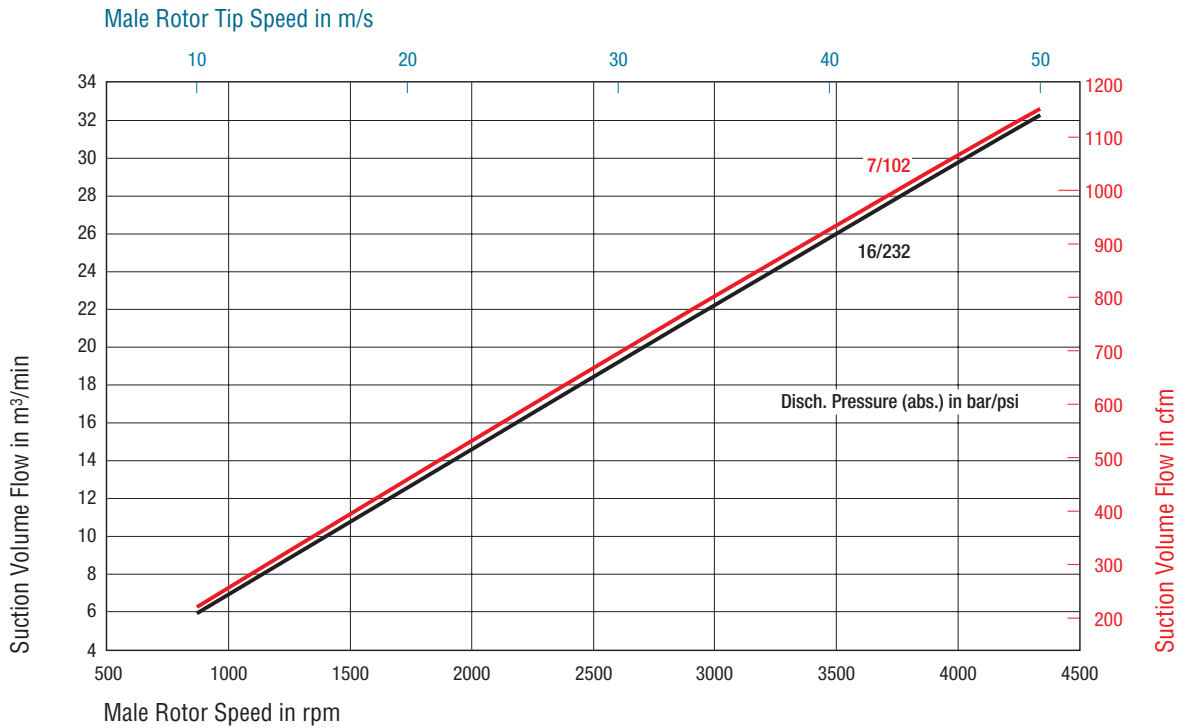

Medium: air; relative humidity: 60%; suction press. (abs.): 1 bar/14.5 psi;
 suction temp.: 20°C/68°F; disch. temp.: 80°C/176°F; oil quality: ISO VG46

* Preliminary data. Subject to change.

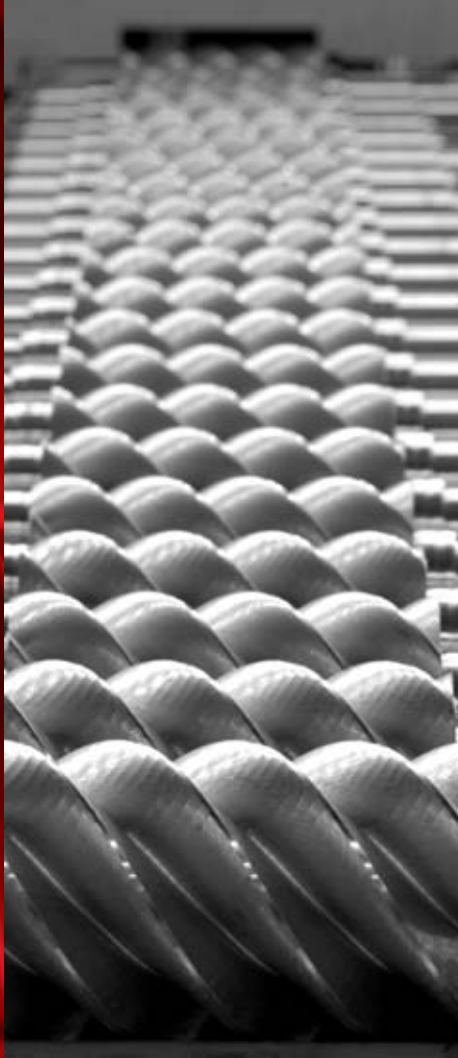

s e r v i c e s

Components

You can choose from a wide selection of components, all of which have been specifically designed for our airends in order to optimize efficiency and reliability when operating in your compressor package. These components are proven designs and can be supplied in airend kits to help reduce your costs and your logistics. Inlet valves, minimum pressure valves, thermostats and combination blocks are all available for you to select with our airends.

Lubricant

Your compressor system will last longer and be more reliable when using our high quality mineral and synthetic coolants Primecool and Primecool Plus. These lubricants have been engineered with excellent start up and operating lubrication characteristics. Not only will this provide long life, excellent cooling performance and improved compressor efficiency but you will also benefit from extended warranty when using these lubricants.

Controls

If you require electronic controls for your compressor package then we can help. We have developed two types of electronic multifunctional controls in accordance with EC standards which can meet a wide variety of your requirements.

Aftermarket Service

We maintain stock of original spare parts and exchange airends in order to meet your demand. We also have a comprehensive range of rebuild kits and a factory rebuild service for our entire product portfolio, along with a dedicated team of specialists to help you with any special requirements you may have.

Engineering Services

Our engineering services bring you peace of mind and can help you to develop and improve your packages. Our experienced and capable engineering office supports all our customers by working with your teams to find solutions for each airend and component application. Whatever your application, we have the experience, the right product and the optimum system solution in order to save costs without loss of quality or reliability.

GHH RAND

passion beyond compression

GHH RAND

Schraubenkompressoren GmbH

Steinbrinkstraße 1

46145 Oberhausen

Germany

Tel +49 (0) 208 699-4111

Fax +49 (0) 208 699-4006

info_ghh-rand@irco.com

www.ghh-rand.com